

Petra

*Petra Development &
Tourism Region
Authority*

***Petra Development & Tourism
Region Authority***

*Downtown library - furniture
Part 3*

2019

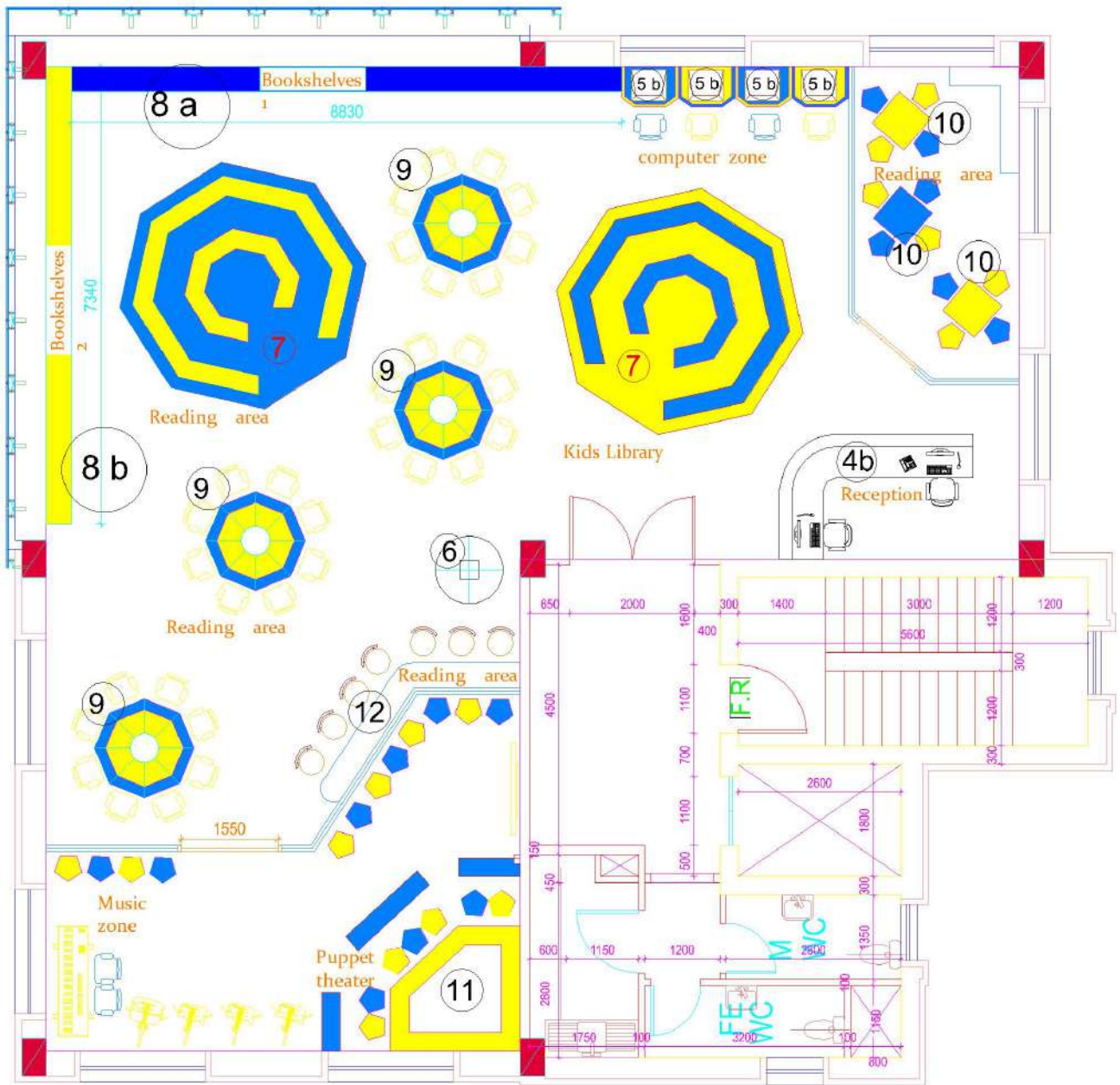

Petra
Petra Development & Tourism Region Authority

Project Name: **Parishute Details**

Scale	1:100	Sheet No.	2 / 1
Plan	Arch. : <i>Sajida Almazni</i>	Arch. : <i>Sama Almazni</i>	

Second floor plan

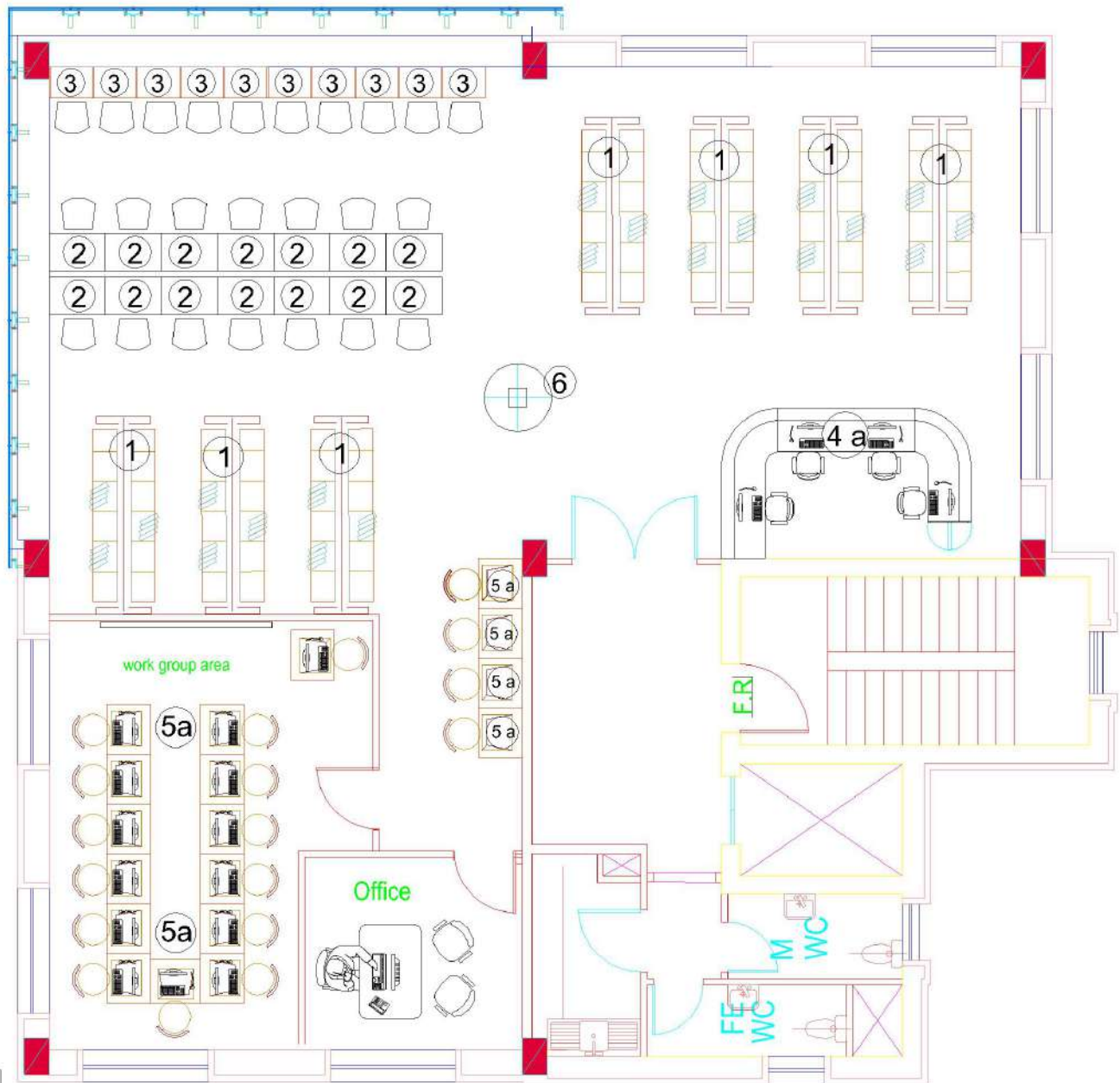

Third floor plan

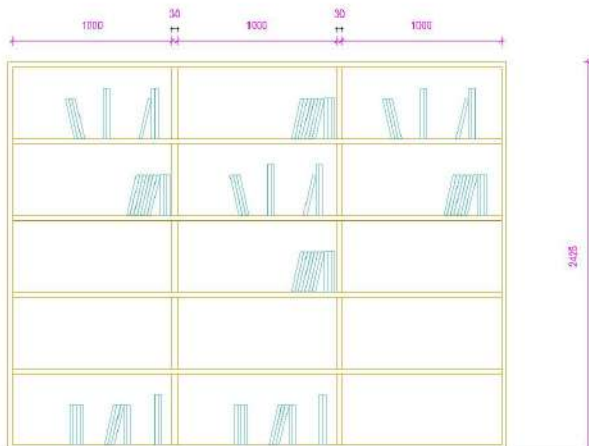
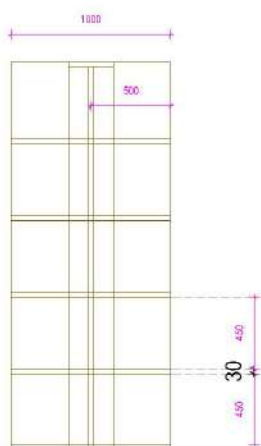
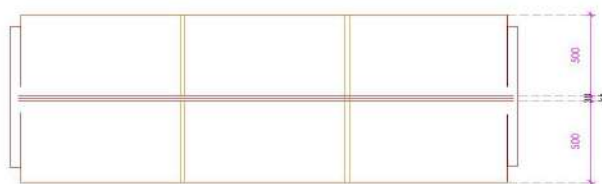

Petra
 Petra Development & Tourism Region Authority

drawing title:		Partitions Details	
scale:	revision no.:	drawing no.:	sheet no.:
1:100	01/02	303/03	3/1
Plan	Arch. : Salsba Amarat Arch. : Sama Basmat		

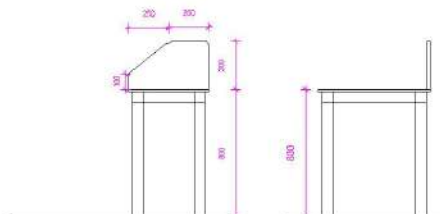
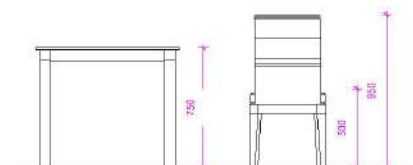
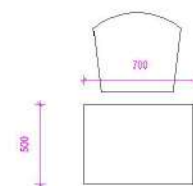
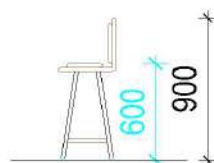
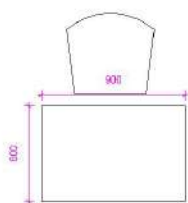

1

7



2

14

3

10



Petra	
FURNITURE & INTERIOR DESIGN	
Jalan ...	
...	
...	
...	

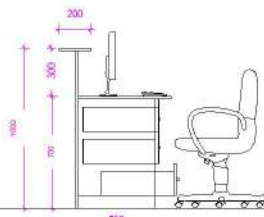
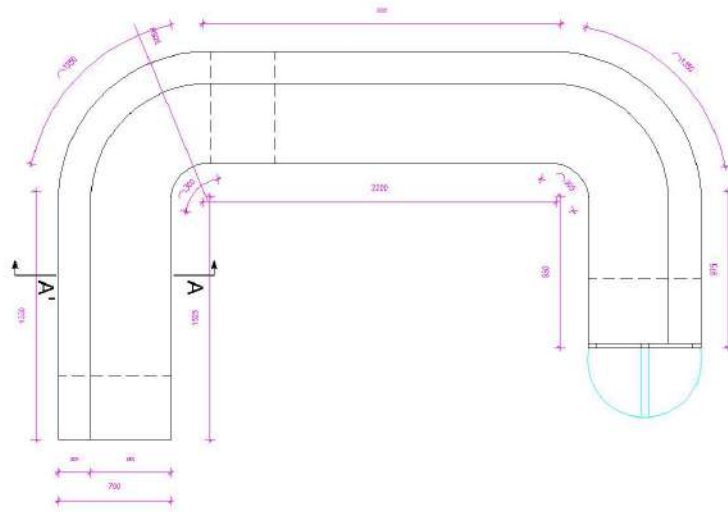

Section A-A

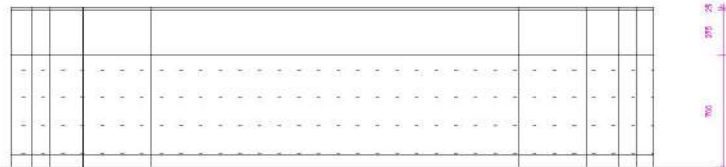

Elevation

4a

1

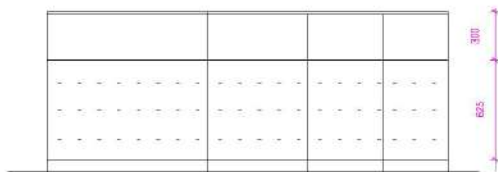

Elevation

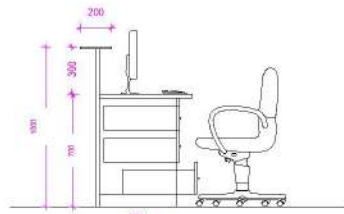

Section A-A

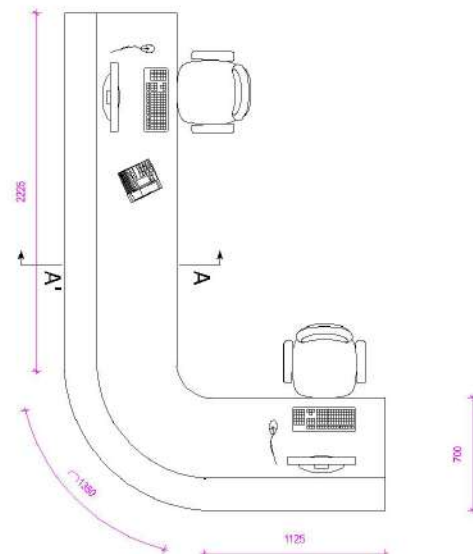

Plan

4 b

1



Petra	
Furniture Details	
Scale	1:50
Rev.	01
Drawn by	JMA - Jyoti Anand
Checked by	Arch. Samee Razaee

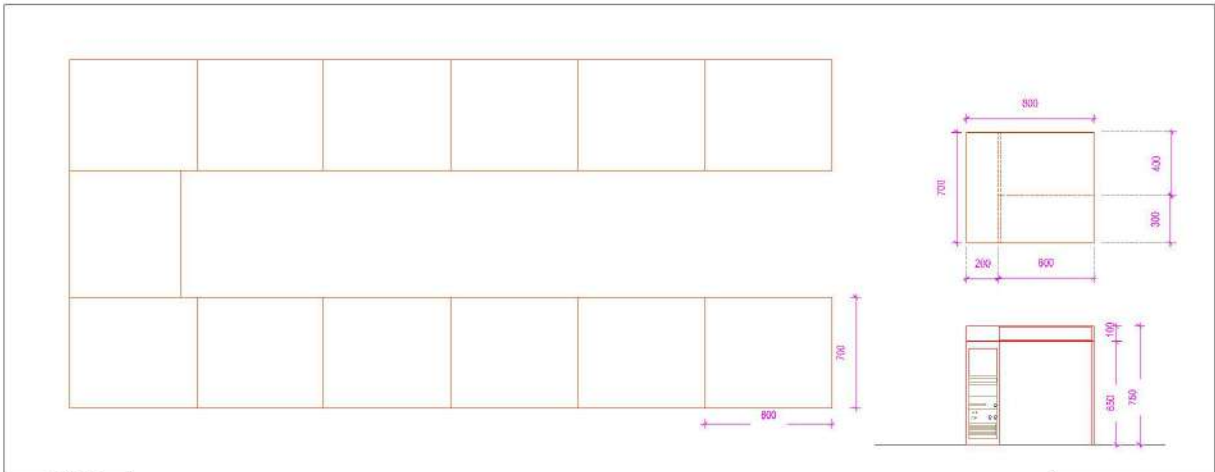

5a

17

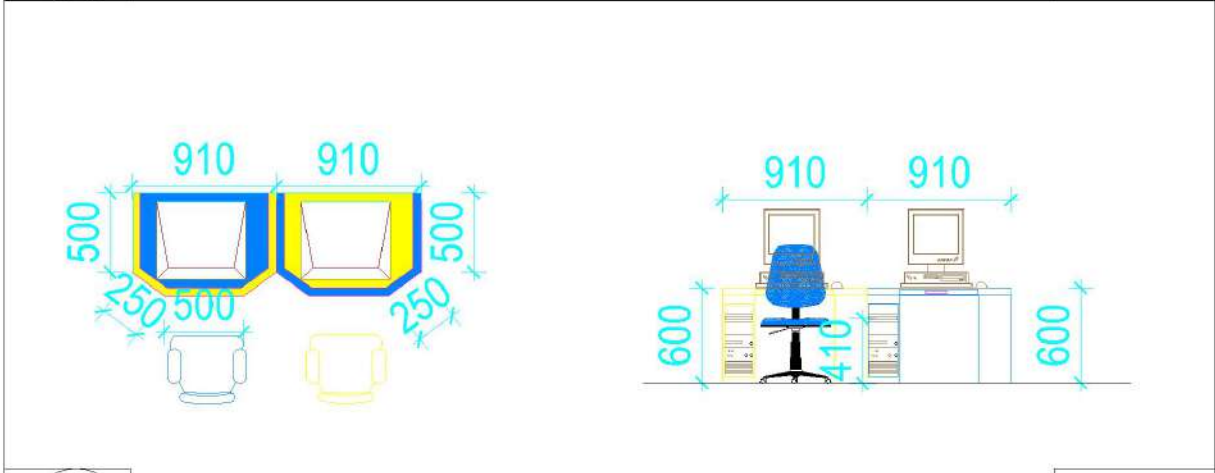

5b

4



 Petra <small>Produktentwicklung & Vertrieb</small>	
<small>Produkt</small>	
<small>Modell</small>	<small>Produktname</small>
<small>Maße</small>	<small>Hersteller</small>

400 300 400

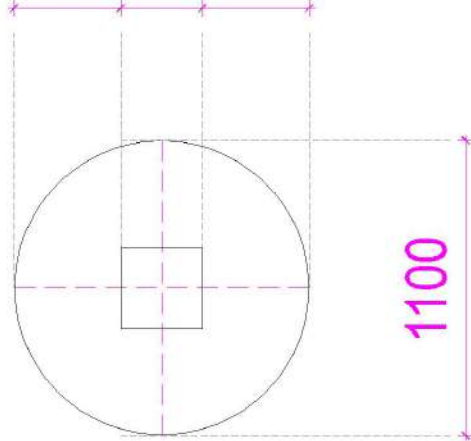

1100

لصو
اڻيڊح

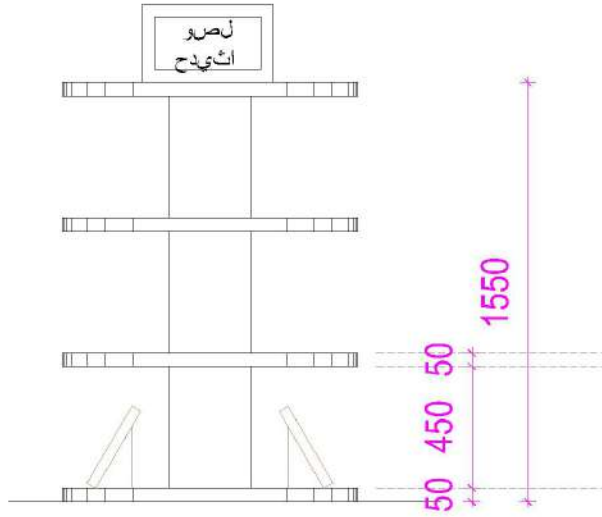

50 450 50 1550

6

2

 **Petra**
Petra Development & Tourism Service Authority

GRAPHIC TITLE: Petra's Details

SCALE	DATE	DESIGNED BY
1:10	18/10	g. y.
Plan	Arch. : Oqba Alkhatib	
	Arch. : Oqba Alkhatib	

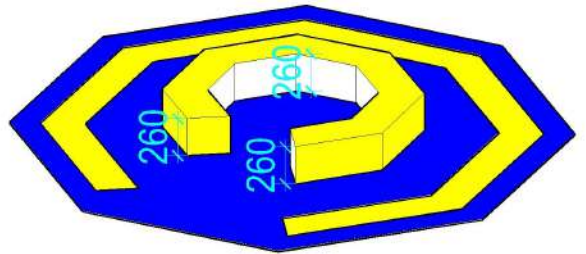
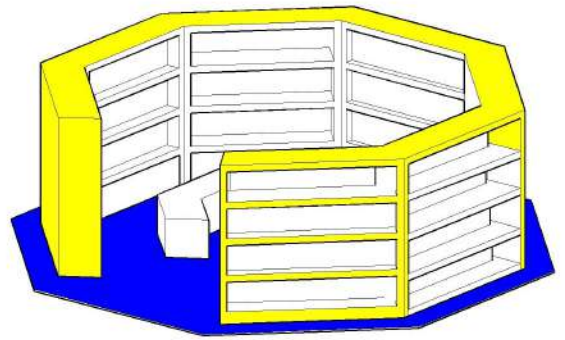
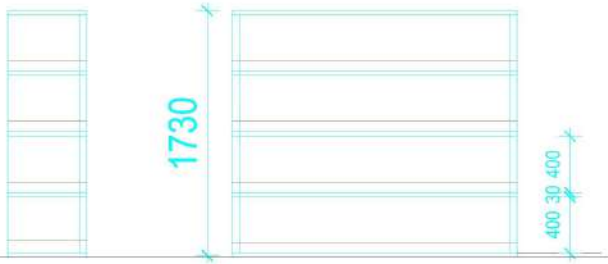
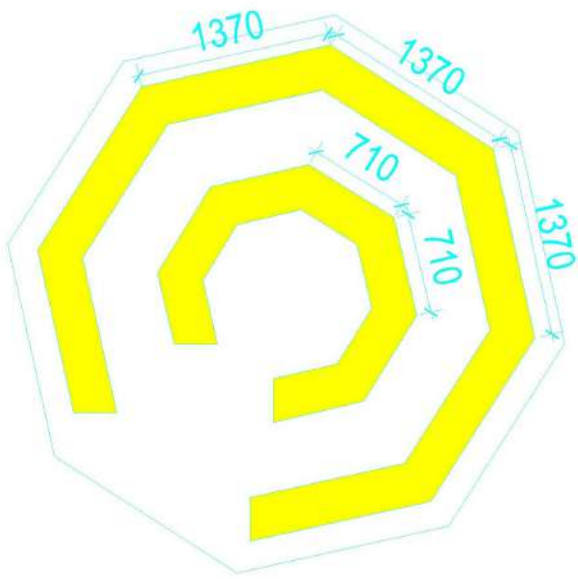

7

2

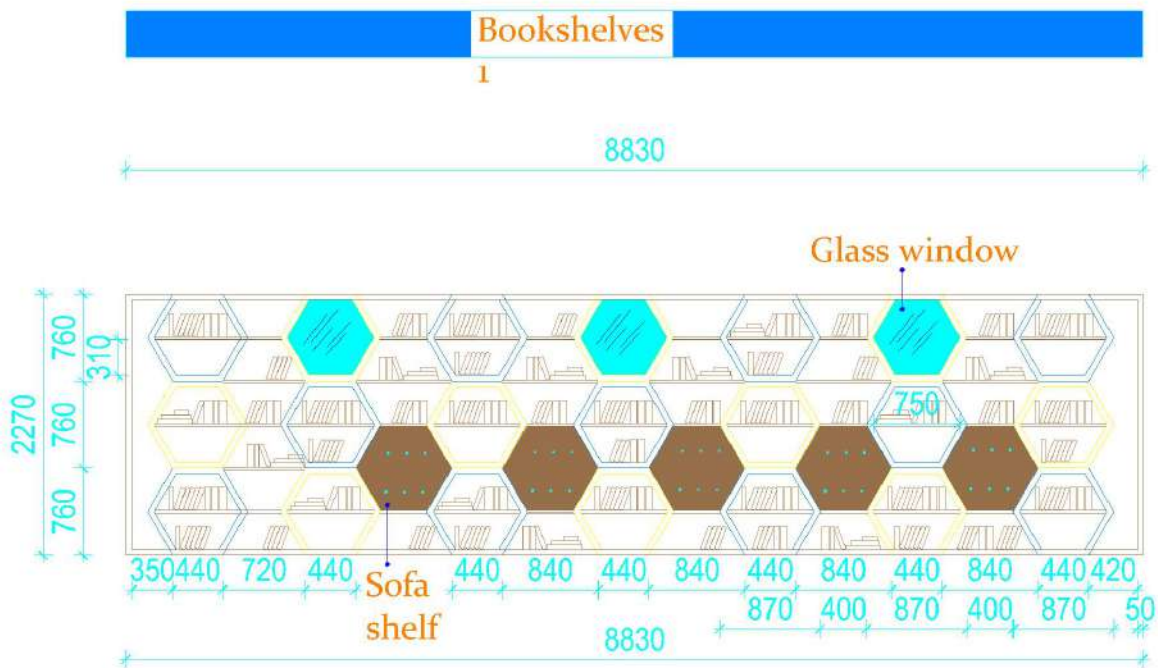

8 a

1

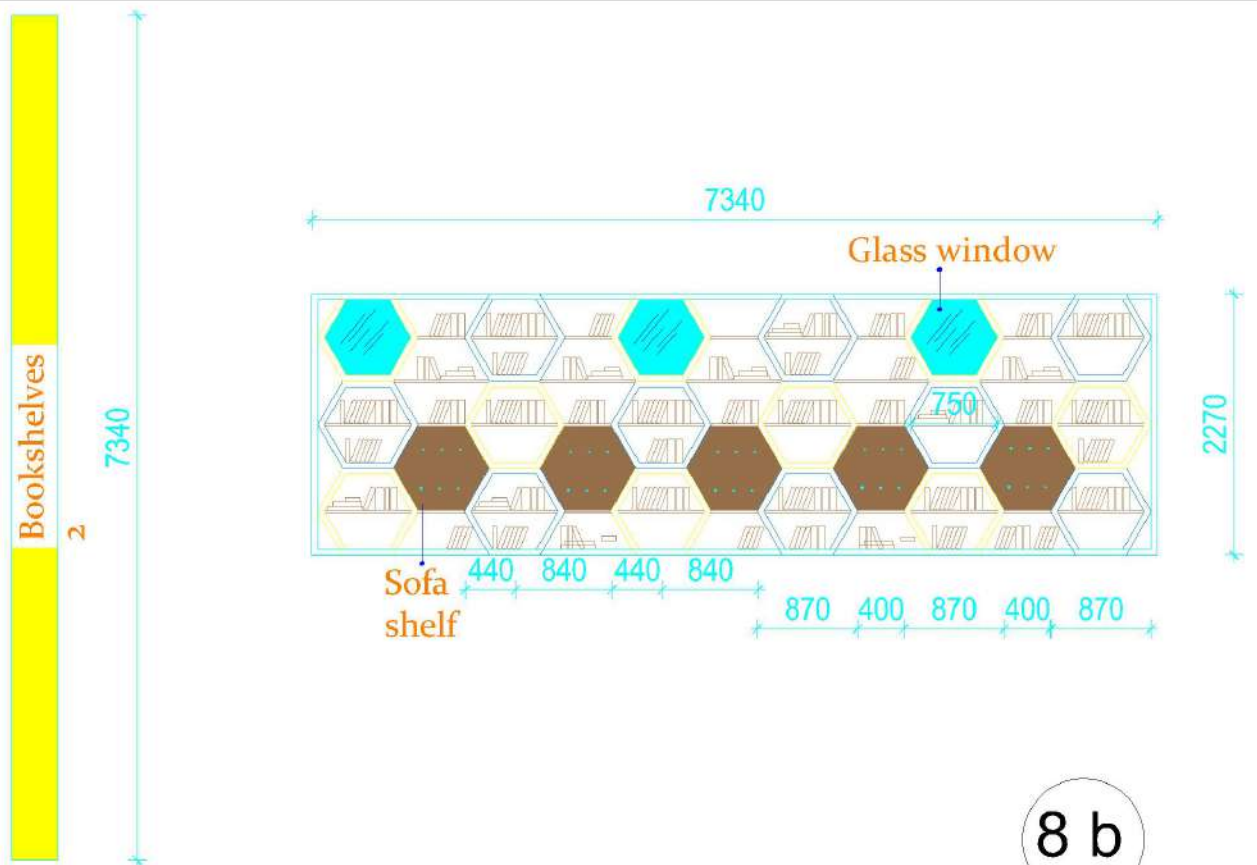

8 b

1

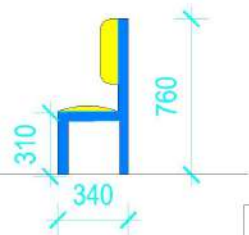
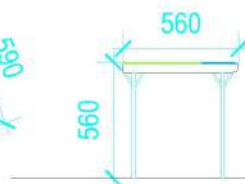
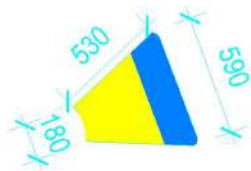
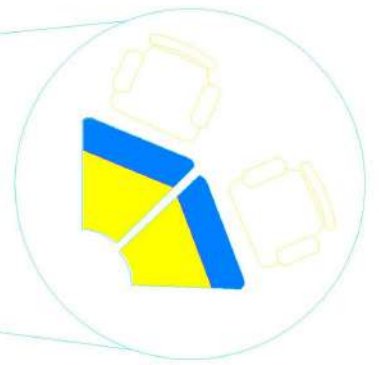
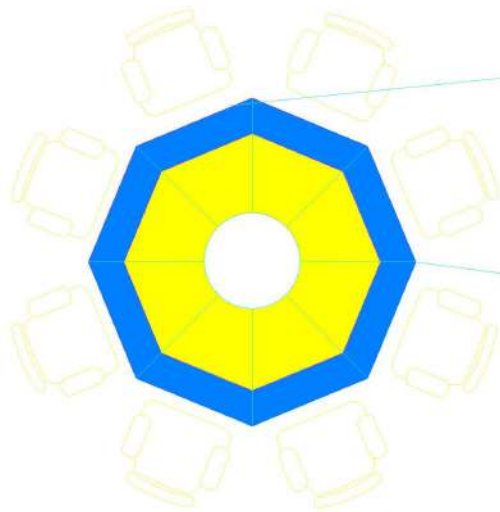

Petra
Perencanaan & Konstruksi Bangunan

Nama Mata Kuliah : Perencanaan	
Nama Dosen : ...	
No. Absen : ...	
Nama : ...	
No. Absen : ...	

9

4 Groups

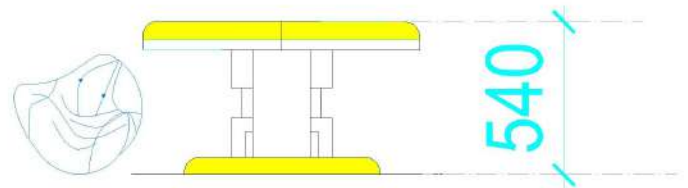
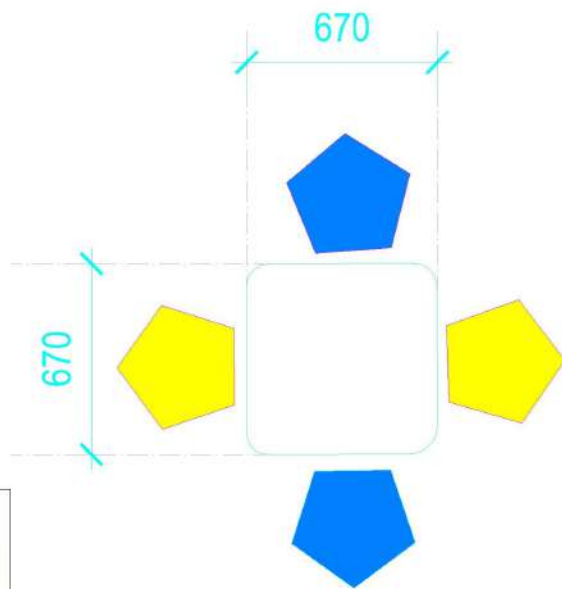

Kategori Item		
Particulars Details		
No	Particulars	Quantity
10	Arch. - Stupa Binarat	1
11	Arch. - Stupa Binarat	1

10

3

